

PRO-91 150-Channel Handheld Trunking Scanner

Please read before using this equipment.

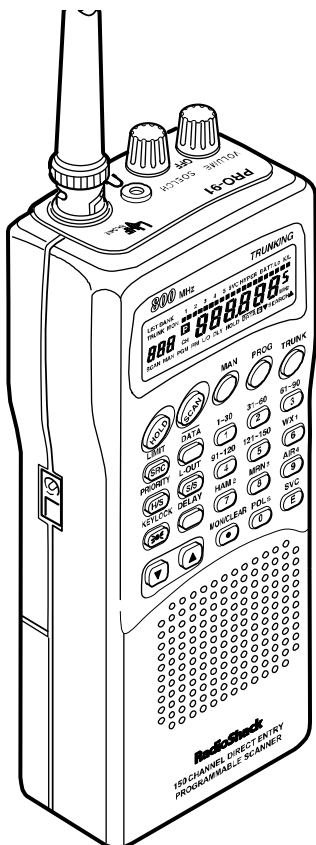

RadioShack®

FEATURES

Your RadioShack PRO-91 150-Channel Handheld Trunking Scanner is one of a new generation of scanners designed to track Motorola Type I and Type II (such as Smartnet and Privacy Plus) and hybrid analog trunking systems, which are extensively used in many 800 MHz communication systems.

Trunking communications systems let a large group of 2-way radio users (or even different groups of 2-way radio users) efficiently use a large range of frequencies. Instead of selecting a specific frequency for a transmission, the user simply selects a talk group. The trunking system automatically transmits the call on the first available frequency, and also sends (on a different frequency called a data channel) a code that uniquely identifies that transmission.

Since the trunking system might send a call and its response on different frequencies, it is difficult to listen to trunked communications using a regular scanner. The PRO-91 lets you select and monitor the data channel frequency sent with a 2-way radio transmission, so you can hear the call and response for that user and more easily "follow" the conversation.

The scanner also lets you scan conventional transmissions, and is preprogrammed with service banks for convenience. By pressing a single button, you can quickly search those frequencies most commonly used by public service and other agencies without tedious and complicated programming.

This scanner gives you direct access to over 30,000 exciting frequencies, including police and fire departments, ambulance services, and amateur radio services, and you can change your selection at any time.

Your scanner also has these special features:

Triple-Conversion Circuitry — virtually eliminates any interference from IF (intermediate frequency) images, so you hear only the selected frequency.

© 1998 Tandy Corporation.
All Rights Reserved.

RadioShack is a registered trademark used by Tandy Corporation.
Hypersearch and Hyperscan are trademarks used by
Tandy Corporation.

Five Channel-Storage Banks — you can store up to 30 channels in each of 5 different banks to group channels so you can more easily identify calls.

Five Scan Lists — you can store up to 50 trunking IDs in each trunk tracking bank.

Two-Second Scan Delay — delays scanning for about 2 seconds before moving to another channel, so you can hear more replies that are made on the same channel.

Lock-Out Function — lets you set your scanner to skip over specified channels or frequencies when scanning or searching, and skip over IDs when tracking trunked systems.

Priority Channels — lets you program one channel in each bank (5 in all) and then have the scanner check that channel every 2 seconds while it scans the bank, so you don't miss transmissions on those channels.

Five Service Banks — frequencies are preset in separate police (fire/emergency), aircraft, ham, marine, and weather banks, to make it easy to locate specific types of calls.

Hypersearch™ — lets you set the scanner to search at up to 300 steps per second. The normal search speed is 100 steps per second.

Hyperscan™ — the scanner automatically scans up to 50 channels per second in frequency bands with 5 kHz steps, to help you quickly find interesting broadcasts.

Key Lock — lets you lock the scanner's keys to help prevent accidental changes to the scanner's programming.

Data Signal Skip — lets you set the scanner to skip non-modulated or data signals (such as fax or modem transmissions) during searches. This lets the scanner avoid non-voice signals, making a search faster.

Manual Access — lets you directly access any channel.

Liquid-Crystal Display — makes it easy to view and change programming information.

Display Backlight — makes the scanner easy to read in low-light situations.

Flexible Antenna with BNC Connector — provides excellent reception and is designed to help prevent antenna breakage. Or, you can connect an external antenna.

Monitor Memories — let you temporarily store up to 5 frequencies or IDs.

Memory Backup — keeps the frequencies stored in memory for an extended time if the PRO-91 loses power.

Three Power Options — let you power the scanner using internal batteries, external AC power using an optional AC adapter/charger, or DC power using an optional DC cigarette-lighter power cable.

Key Confirmation Tones — the scanner sounds a tone when you perform an operation correctly, and an error tone if you make an error.

Battery Save — saves battery power when the scanner does not detect any transmissions for more than 5 seconds when a channel is manually selected.

Battery Low Alert — warns you when battery power gets low.

Your scanner can receive these bands:

Frequency Range (MHz)	Step (kHz)	Transmission
29–29.7	5	10-Meter Ham Band
29.7–50	5	VHF Lo
50–54	5	6-Meter Ham Band
108–136.9750	12.5	Aircraft
137–144	5	Military Land Mobile
144–148	5	2-Meter Ham Band
148–174	5	VHF Hi
406–420	12.5	Federal Government
420–450	12.5	70-cm Ham Band
450–470	12.5	UHF Standard Band
470–512	12.5	UHF “T” Band
806–956	12.5	Public Service “800” Band, except cellular band

We recommend you record your scanner's serial number here. The number is on the back panel.

Serial Number: _____

FCC NOTICE _____

Your scanner might cause radio or TV interference even when it is operating properly. To determine whether your scanner is causing the interference, turn off your scanner. If the interference goes away, your scanner is causing it. Try the following methods to eliminate the interference:

- Move your scanner away from the receiver
- Connect your scanner to an outlet that is on a different electrical circuit from the receiver
- Contact your local RadioShack store for help

Note: Mobile use of this scanner is unlawful or requires a permit in some areas. Check the laws in your area.

SCANNING LEGALLY

Your scanner covers frequencies used by many different groups including police and fire departments, ambulance services, government agencies, private companies, amateur radio services, military operations, pager services, and wireline (telephone and telegraph) service providers. It is legal to listen to almost every transmission your scanner can receive. However, there are some transmissions you should never intentionally listen to. These include:

- Telephone conversations (cellular, cordless, or other private means of telephone signal transmission)
- Pager transmissions
- Any scrambled or encrypted transmissions

According to the Electronic Communications Privacy Act (ECPA), you are subject to fines and possible imprisonment for intentionally listening to, using, or divulging the contents of such a transmission unless you have the consent of a party to the communication (unless such activity is otherwise illegal).

This scanner is designed to prevent reception of illegal transmissions, in compliance with the law which re-

quires that scanners be manufactured in such a way as to not be easily modifiable to pick up those transmissions. Do not open your scanner's case to make any modifications that could allow it to pick up transmissions that it is not legal to listen to. Doing so could subject you to legal penalties.

We encourage responsible, legal scanner use.

CONTENTS

Preparation	10
Power Sources	10
Using Internal Batteries	10
Charging Nickel-Cadmium Batteries	12
Using AC Power	13
Using Vehicle Battery Power	14
Connecting the Antenna	16
Connecting an Optional Antenna	16
Connecting an Earphone/Headphones	17
Listening Safely	17
Traffic Safety	17
Connecting an Extension Speaker	18
Attaching the Belt Clip	18
About Your Scanner	19
A Look at the Keypad	20
A Look at the Display	21
Understanding Banks	23
Service Banks	23
Channel Storage Banks	23
Monitor Memories	24
Operation	25
Turning On the Scanner/Setting Squelch	25
Storing Known Frequencies into Channels	26
Searching For and Temporarily Storing	
Active Frequencies	27
Limit Search	27
Direct Search	28
Service Bank Search	29
Search Skip Memory	30
Listening to the Monitor Memories	31
Moving a Frequency From a Monitor Memory	
to a Channel	31
Scanning the Stored Channels	32
Manually Selecting a Channel	32

Special Features	34
Delay	34
Turning Channel-Storage Banks On and Off ...	34
Locking Out Channels	35
Priority	35
Using the Keylock	37
Using the Display Backlight	37
Changing Search Speeds	37
Turning the Key Tone Off/On	38
Turning the Battery Save Function Off/On	38
Skipping Data Signals	39
Trunk Tracking	40
Types of Trunking Systems	40
Setting the Scanner to the	
Trunk Tracking Mode	41
Setting Squelch for the Trunk Tracking Mode ..	42
Storing Trunked Frequencies	42
Scanning a Trunked Bank	44
Monitoring an Active ID	45
Temporarily Storing an ID into the	
Monitor ID Memory	45
Locking Out IDs	46
Unlocking a Single ID	46
Unlocking All IDs	46
Using Trunk Tracking Scan Delay	47
Monitoring IDs	47
Channel Activity Bars	48
Scan Lists	49
Manually Storing IDs into Scan Lists	49
Moving IDs to Scan Lists	50
Deleting a Stored ID	50
Scanning the Scan Lists	51
Scanning Type I and Hybrid Trunked	
Systems	51
Selecting a Preset Fleet Map	55
Programming a Fleet Map	56
Programming a Hybrid System	57
A General Guide to Scanning	58
Guide to Frequencies	58
National Weather Frequencies	58
Canadian Weather Frequencies	58
Birdie Frequencies	58
Guide to the Action Bands	59
Typical Band Usage	59
Primary Usage	59
Band Allocation	60

Frequency Conversion 63

Troubleshooting 64

Resetting the Scanner 67

Care and Maintenance 68

Specifications 69

PREPARATION

POWER SOURCES

You can power your scanner from any of three sources:

- Internal batteries (not supplied)
- Standard AC power (using an optional AC adapter)
- Vehicle battery power (using an optional DC adapter)

Using Internal Batteries

You can power your scanner using four AA batteries. For the longest operation and best performance, we recommend alkaline batteries (such as Cat. No. 23-552).

You can also use four rechargeable nickel-cadmium batteries (Cat. No. 23-125). Before you use nickel-cadmium batteries, you must charge them (see “Charging Nickel-Cadmium Batteries” on Page 11).

Follow these steps to install batteries.

1. Turn **VOLUME/OFF** counterclockwise until it clicks to make sure the power is turned off.

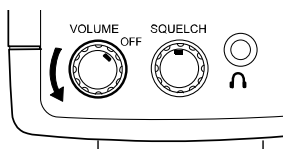

2. Slide up and hold the tab on the back of the scanner, then pull up the battery compartment cover.

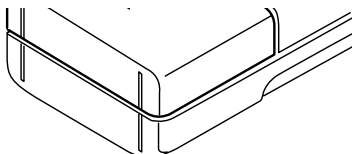

-
-
3. If you are installing alkaline batteries, use a pointed object such as a pencil to set **ALKALINE** ◀ **JACK** ▶ **NI-CD** inside the compartment to **ALKALINE**. Or, if you are installing nickel-cadmium batteries, set it to **NI-CD**.

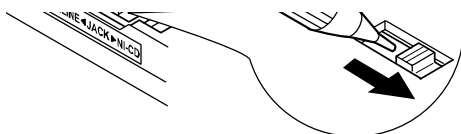

Warning: Never set **ALKALINE** ◀ **JACK** ▶ **NI-CD** to **NI-CD** if you are installing non-rechargeable batteries. Non-rechargeable batteries can get hot or explode if you try to recharge them.

4. Install two batteries in the compartment and two in the cover as indicated by the polarity symbols (+ and -) marked inside those locations.

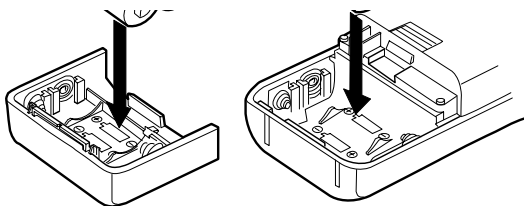

Cautions:

- Use only fresh batteries of the required size and recommended type.
- Always remove old or weak batteries. Batteries can leak chemicals that destroy electronic circuits.
- Do not mix old and new batteries, different types of batteries (standard, alkaline, or rechargeable), or rechargeable batteries of different capacities.

5. Replace the cover.

If **BATT Lo** flashes and the scanner beeps every 15 seconds, replace (standard/alkaline) or recharge (rechargeable nickel-cadmium) the batteries.

Caution: Always dispose of old batteries promptly and properly. Do not bury or burn them.

Charging Nickel-Cadmium Batteries

The scanner has a built-in circuit that lets you recharge nickel-cadmium batteries while they are in the scanner. To charge the batteries, set **ALKALINE ◀ JACK ▶ NI-CD** to **NI-CD**, install the nickel-cadmium batteries in the scanner, and connect an external AC or DC adapter to the scanner's **POWER** jack (see "Using AC Power" on Page 12 or "Using Vehicle Battery Power" on Page 13).

Warning: Do not connect either adapter to the scanner if non-rechargeable batteries (such as alkaline batteries) are installed in the scanner and **ALKALINE ◀ JACK ▶ NI-CD** is set to **NI-CD**, or you are unsure of the switch's position. Non-rechargeable batteries will get hot and can even explode if you try to recharge them.

Before you use nickel-cadmium batteries for the first time, charge them at least 24 hours to bring them to a full charge.

Discharged batteries take about 10 to 18 hours to fully recharge. If you use the scanner while the batteries are charging, charging takes longer.

Notes:

- Nickel-cadmium batteries last longer and deliver more power if you occasionally let them fully discharge. To do this, simply use the scanner until it beeps every 15 seconds and **BATT Lo** flashes.
- To prevent damage to nickel-cadmium batteries, never charge them in an area where the temperature is above 113°F or below 40°F.

Important: At the end of a rechargeable battery's useful life, it must be recycled or disposed of properly. Contact your local, county, or state hazardous waste management authorities for information on recycling or disposal programs in your area. Some options that might be available are: municipal curb-side collection, drop-off boxes at retailers such as your local RadioShack store, recycling collection centers, and mail-back programs.

Using AC Power

You can power the scanner from a standard AC outlet using an optional AC adapter (such as Cat. No. 273-1665).

Warning: Do not use an AC adapter's polarized plug with an extension cord, receptacle, or other outlet unless the blades can be fully inserted to prevent blade exposure.

Cautions:

- The recommended AC adapter supplies 9 volts and delivers at least 300 milliamps. It has a barrel plug with a center negative tip that correctly fits the scanner's **POWER** jack. Using an adapter that does not meet these specifications could damage the scanner or the adapter.
- To protect your scanner and AC adapter, always plug the adapter into the scanner before you plug it into the AC outlet, and always unplug the adapter from the AC outlet before you unplug it from the scanner.
- If batteries are installed, make sure the battery switch inside the battery compartment is set to the correct position (see "Using Internal Batteries" on Page 9).

-
1. Turn **VOLUME/OFF** counterclockwise until it clicks to make sure the power is turned off.
 2. Plug the adapter's 3.4 mm outside diameter/1.3 mm inside diameter barrel plug into your scanner's **POWER** jack.

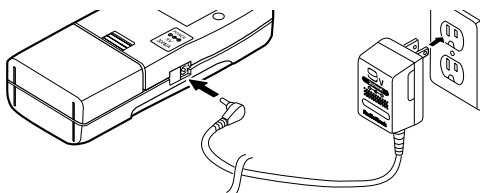

3. Plug the other end of the adapter into a standard AC outlet.

If rechargeable batteries are installed and **ALKALINE** ◀ **JACK** ▶ **NI-CD** is set to **NI-CD**, the adapter powers the scanner and recharges the batteries at the same time.

Using Vehicle Battery Power

You can power the scanner from your vehicle's battery power using an optional DC adapter such as Cat. No. 270-1560.

Cautions:

- The recommended DC adapter supplies 9 volts and delivers at least 300 milliamps. It has a barrel plug with a center negative tip that correctly fits the scanner's **POWER** jack. Using an adapter that does not meet these specifications could damage the scanner or the adapter.
- To protect your vehicle's electrical system, always plug the adapter into the scanner before you plug it into your vehicle's cigarette-lighter socket. Always unplug the adapter from the vehicle's cigarette-lighter socket before you unplug it from the scanner.
- If batteries are installed, make sure the battery switch inside the battery compartment is set to the correct position (see "Using Internal Batteries" on Page 9).

-
1. Turn **VOLUME/OFF** counterclockwise until it clicks to make sure the power is turned off.
 2. Set the adapter's voltage switch to 9V.
 3. Connect the 3.4 mm outer diameter/1.3 mm inner diameter tip to the adapter cord, matching **TIP** to **-**.
 4. Plug the adapter's barrel plug into your scanner's **POWER** jack.

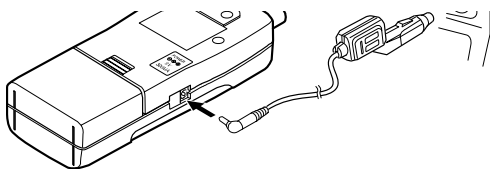

5. Plug the other end of the adapter into your vehicle's cigarette-lighter socket.

If you have installed rechargeable batteries and set **ALKALINE** ◀ **JACK** ▶ **NI-CD** to **NI-CD**, the adapter powers the scanner and recharges the batteries at the same time.

Note: If the scanner does not operate properly when you use a DC adapter, unplug the adapter from the cigarette-lighter socket and clean the socket to remove ashes and debris.

CONNECTING THE ANTENNA

Follow these steps to attach the supplied flexible antenna to the connector on the top of your scanner.

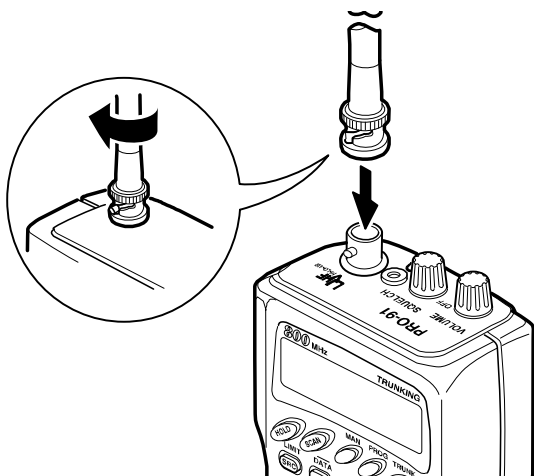

1. Align the slots around the antenna's connector with the tabs on the scanner's BNC connector.
2. Slide the antenna's connector down over the scanner's connector and rotate the antenna connector's outer ring clockwise until it locks into place.

Connecting an Optional Antenna

The scanner's BNC connector makes it easy to connect a variety of optional antennas (such as an external mobile antenna or outdoor base station antenna). Your local RadioShack store sells a variety of antennas.

Note: Always use 50-ohm coaxial cable, such as RG-58 or RG-8, to connect an outdoor antenna. If the distance from the scanner to the antenna is over 50 feet, use RG-8 low-loss dielectric coaxial cable. If your antenna's cable does not have a BNC connector, your local RadioShack store carries a variety of BNC adapters.

CONNECTING AN EARPHONE/ HEADPHONES

For private listening, you can plug an earphone or mono headphones (such as Cat. No. 33-178 or 20-210) into the  jack on top of your scanner. This automatically disconnects the internal speaker.

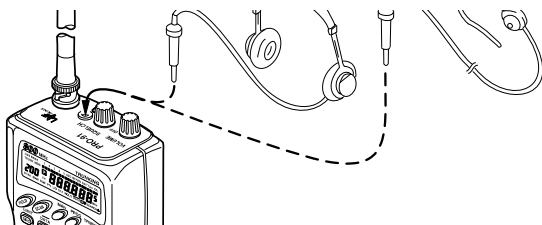

Listening Safely

To protect your hearing, follow these guidelines when you use an earphone or headphones.

- Do not listen at extremely high volume levels. Extended high-volume listening can lead to permanent hearing loss.
- Set the volume to the lowest setting before you begin listening. After you begin listening, adjust the volume to a comfortable level.
- Once you set the volume, do not increase it. Over time, your ears adapt to the volume level, so a volume level that does not cause discomfort might still damage your hearing.

Traffic Safety

Do not use an earphone or headphones with your scanner when operating a motor vehicle in or near traffic. Doing so can create a traffic hazard and could be illegal in some areas.

If you use an earphone or headphones with your scanner, be very careful. Do not listen to a continuous broadcast. Even though some earphones/headphones let you hear some outside sounds when listening at normal volume levels, they still can present a traffic hazard.

CONNECTING AN EXTENSION SPEAKER

In a noisy area, an extension speaker (such as Cat. No. 21-549), positioned in the right place, might provide more comfortable listening. Plug the speaker cable's $\frac{1}{8}$ -inch mini-plug into your scanner's  jack.

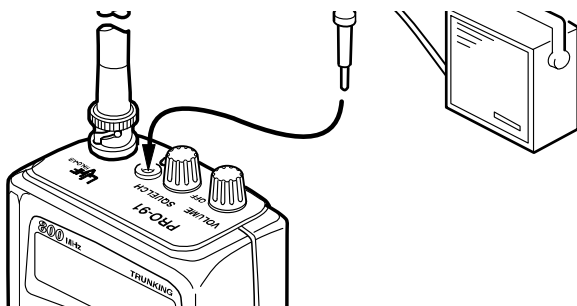

ATTACHING THE BELT CLIP

You can attach the supplied belt clip to make your scanner easier to use when you are on the go. Use a Phillips screwdriver and the supplied screws to attach the belt clip to the scanner. Then slide the clip over your belt or waistband.

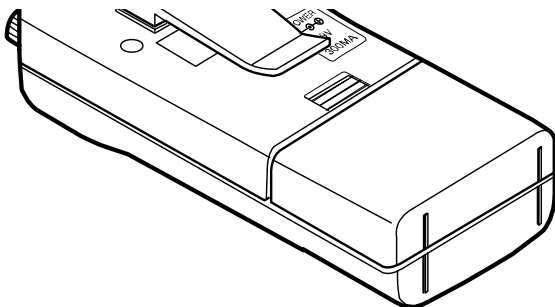

ABOUT YOUR SCANNER

Once you understand a few simple terms we use in this manual and familiarize yourself with your scanner's features, you can put the scanner to work for you. You simply determine the type of communications you want to receive, then set the scanner to scan those communications.

A **frequency** is the tuning location of a station (expressed in kHz or MHz). To find active frequencies, you use the **search** function.

Besides searching within a frequency range you determine, you can also search your scanner's **service banks**. Service banks are preset groups of frequencies categorized by type of service. For example, many amateur radio frequencies are located in the **HAM2** service bank.

When you find a frequency, you can store it into a programmable memory location called a **channel**. Channels are grouped into **channel-storage banks**. (This scanner has 5 channel-storage banks of 30 channels each). You can then **scan** the channel-storage banks to see if there is activity on the frequencies stored there.

Or, when you find a frequency, you can store it into a temporary memory location called a monitor memory until you decide whether or not to move it to a channel.

Just keep in mind — you *search* frequencies and *scan* channels.

You can also use your scanner to track trunked transmissions (see "Trunk Tracking" on Page 39).

A LOOK AT THE KEYPAD

Your scanner's keys might seem confusing at first, but this information should help you understand each key's function.

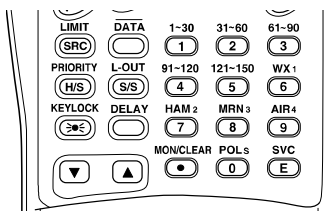

HOLD — holds the frequency search; holds on the current ID in the trunk tracking mode.

SCAN — scans through the stored channels.

MAN (manual) — stops scanning and lets you directly enter a channel number or frequency.

PROG (program) — stores frequencies into channels; programs the trunking frequency, fleet map, and ID memories.

TRUNK — switches between conventional and trunk tracking.

LIMIT/SRC (search) — starts a limit search; searches a specified frequency range to find frequencies; searches for another active ID while trunk tracking.

DATA — turns on or off the data signal skip feature; moves through menu settings while trunk tracking.

PRIORITY/H/S (Hypersearch) — sets and turns on and off the priority feature; turns on and off Hypersearch.

L-OUT/S/S (search skip) — lets you lock out selected channels or skip specified frequencies during a search; lets you lock out a selected ID while trunk tracking.

KEYLOCK/☛●☚ — locks the keypad to prevent accidental program changes; turns on the display light for 15 seconds.

DELAY — programs a 2-second delay for the selected channel, a limit search, or each service scan; programs a 5-second delay while trunk tracking.

t — searches down through a selected frequency range during a frequency search; selects options during program operation; changes the ID location number while trunk tracking.

s — searches up through a selected frequency range during a frequency search; selects options during program operation; changes the ID location number while trunk tracking.

Number Keys — each key has a single-digit label and a range of numbers. The single digits are used to enter a channel, frequency, service bank, or ID number. The range of numbers (31–60, for example) are used to enter the channels that make up a memory bank.

MON/CLEAR/● — stores frequencies into monitor memories during a search; recalls frequencies from monitor memories when programming a channel; stores searched IDs into monitor memories or selects options while trunk tracking; enters a decimal point or clears an incorrect entry.

SVC (service)/E (enter) — starts a service bank search; enters frequencies into channels.

A LOOK AT THE DISPLAY

The display has indicators that show the scanner's current operating status. A good look at the display will help you understand how your scanner operates.



BANK — appears with numbers (1–5). The numbers show which channel-storage banks are turned on for scanning.

TRUNK — appears when the scanner is set for trunk tracking.

■ (trunking channel activity bars) — each represents a received trunking frequency or a data frequency while trunk tracking (see “Channel Activity Bars” on Page 47).

- 1 - — appears when the weather service band is selected.

- 2 - — appears when the amateur radio service band is selected.

- 3 - — appears when the marine service band is selected.

- 4 - — appears when the air service band is selected.

- 5 - — appears when the police service band is selected.

P — appears when a priority channel is selected.

BATT . Lo — blinks when the scanner’s battery is low.

DATA — appears when the data skip function is active.

SCAN — appears when you scan channels.

LIST — appears with numbers (1–5) during trunk tracking. Numbers with a bar under them show which ID scan list banks are turned on for scanning.

SVC — appears during a service search.

SEARCH — appears during a limit search and ID search, and blinks when you monitor IDs (see “Monitoring IDs” on Page 46).

PRI — appears when the priority feature is turned on.

HOLD — appears when you manually select a channel or when the scanner is holding during a search.

DLY — appears when you program a delay.

L/O — appears when you manually select a channel or frequency you locked out.

K/L (keylock) — appears when you lock the keypad.

Error — appears when you make an entry error.

MON — appears during search modes or when you select a monitor memory. The number to the right of

this indicator shows the current monitor memory number.

MAN — appears when you press **MAN**.

PGM — appears while you store a frequency into a channel, while you enter a frequency range during a limit search, or when you program trunking frequencies, fleet maps, or ID memories while trunk tracking.

HYPER — appears while Hyperscan or Hypersearch is active during a direct or limit search.

t and **s** — appears during a limit, direct, or service search, indicating the search direction.

S — appears when the battery save function is active (during conventional scanning only).

UNDERSTANDING BANKS

Service Banks

The scanner is preprogrammed with all the frequencies allocated to the weather, ham, marine, aircraft, and police (fire/emergency) services. This is handy for quickly finding active frequencies instead of doing a limit search (see “Service Bank Search” on Page 28).

Channel Storage Banks

To make it easier to identify and select the channels you want to listen to, channels are divided into 5 banks of 30 channels each. Use each channel-storage bank to group frequencies, such as those for the police department, fire department, ambulance services, or aircraft (see “Guide to the Action Bands” on Page 58).

For example, the police department might use four frequencies, one for each side of town. You could program the police frequencies starting with Channel 1 (the first channel in bank 1), and program the fire department frequencies starting with Channel 31 (the first channel in bank 2).

Monitor Memories

The scanner also has 5 temporary memory locations called monitor memories. You can use these monitor memories to temporarily store frequencies while you decide whether to store them into a channel. This is handy for quickly storing an active frequency when you search through an entire band (see “Searching For and Temporarily Storing Active Frequencies” on Page 26).

While you are searching frequencies, the 5 numbers at the top of the display indicate the 5 monitor memories. **MON** appears and the number beside it that flashes indicates the currently active monitor memory.

OPERATION

TURNING ON THE SCANNER AND SETTING SQUELCH

Note: Make sure the scanner's antenna is connected before you turn it on.

1. Turn **SQUELCH** fully counterclockwise.

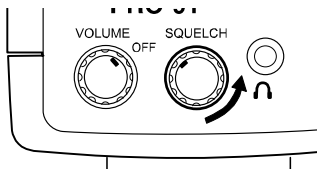

2. Turn **VOLUME/OFF** clockwise until it clicks and you hear a hissing sound.

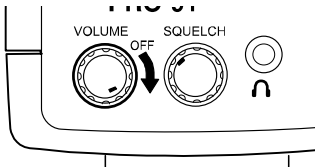

3. Press **MAN** (manual) to stop the scanner from scanning, turn **SQUELCH** clockwise, then leave it set to a point just after the hissing sound stops.

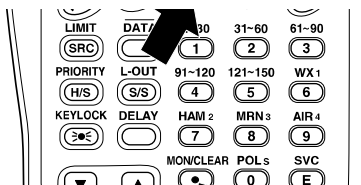

STORING KNOWN FREQUENCIES INTO CHANNELS

Good references for active frequencies are RadioShack's "Beyond Police Call," "Aeronautical Frequency Directory," and "Maritime Frequency Directory." We update these directories every year, so be sure to get a current copy.

Follow these steps to store frequencies into channels.

1. Press **MAN**, enter the channel number where you want to store a frequency, then press **PROG**. The channel number appears.
2. Use the number keys and **•** to enter the frequency (including the decimal point) you want to store.

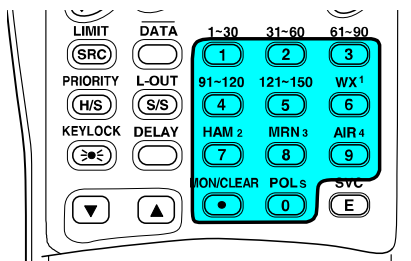

3. Press **E** to store the frequency into the channel.

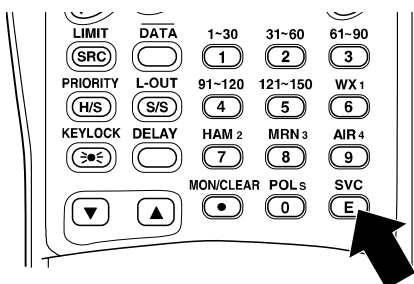

Notes:

- If you entered an invalid frequency in Step 2, **Error** appears and the scanner beeps three times. Simply enter the frequency again.

- Your scanner automatically rounds the entered frequency to the nearest valid frequency. For example, if you enter a frequency of 151.473, your scanner accepts it as 151.475.
 - Press **DELAY** if you want the scanner to pause 2 seconds after a transmission ends before it proceeds to the next channel (see “Delay” on Page 33). The scanner also stores this setting in the channel.
4. If you want to program the next channel in sequence, press **PROG** and repeat Steps 2 and 3.

SEARCHING FOR AND TEMPORARILY STORING ACTIVE FREQUENCIES

If you do not have a reference to frequencies in your area, use a limit, direct, or service search to find a transmission. Also see “Guide to the Action Bands” on Page 58.

Notes: While doing a limit, direct, or service bank search, you can press:

- **DELAY** if you want the scanner to pause 2 seconds after a transmission ends before it proceeds to the next frequency (see “Delay” on Page 33).
- **DATA** if you want the scanner to skip data signals (such as fax or modem signals) and search only for audio (voice) signals (see “Skipping Data Signals” on Page 38).

Limit Search

A limit search lets you search within a specific range of frequencies. **-L-** appears during a limit search.

1. Press **PROG**, then **LIMIT**. **L0** and **29.000 MHz** appear.

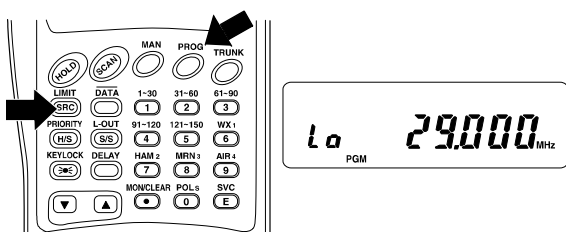

2. Enter the frequency that is the lower limit of the range you want to search (including the decimal point), then press **E**.
3. Press **LIMIT. Hi** and **956.000 MHz** appear.
4. Enter the frequency that is the upper limit of the range you want to search (including the decimal point), then press **E** again.
5. Press **t** to search from the upper to the lower limit, or **s** to search from the lower to the upper limit.

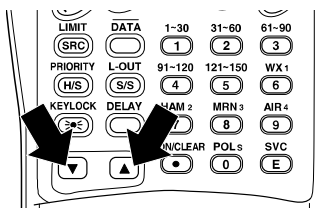

6. When the scanner stops on a transmission, quickly press either:

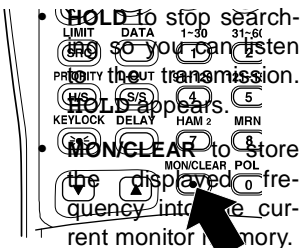

To release hold and continue searching, press **HOLD** or hold down **t** or **s** for at least 1 second. Or, if you did not press **HOLD**, simply press **t** or **s** to continue searching.

Direct Search

Direct search lets you search up or down from the currently displayed frequency.

1. Press **MAN**.
2. Use the number keys to enter the frequency you want to start the search from. Press **.** to enter a decimal point.

Notes:

- If you want to start the search from a frequency already stored in one of your scanner's channels, press **MAN** or **PROG**, use the number keys to enter the channel number, then press **MAN** or **PROG** again.
 - If you enter an invalid frequency, the scanner displays **Error**. Simply repeat this step.
3. Press **t** to search downward or **s** to search upward from the selected frequency. **-d-**, **SEARCH**, and **t** or **s** appear.

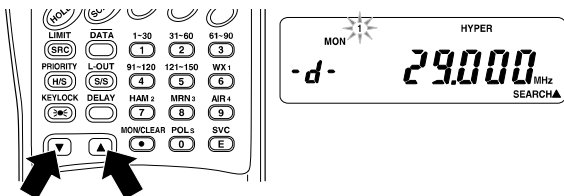

4. When the scanner stops on a transmission, quickly press either:
- **HOLD** to stop searching so you can listen to the transmission. **HOLD** appears.
 - **MON/CLEAR** to store the displayed frequency into the current monitor memory.

To release hold and continue searching, press **HOLD** or hold down **t** or **s** for at least 1 second. Or, if you did not press **HOLD**, simply press **t** or **s** to continue searching.

Note: To step through the frequencies while **HOLD** is displayed, press **t** or **s**.

Service Bank Search

You can search for weather, ham, marine, aircraft, or police (fire/emergency) transmissions even if you do not know the specific frequencies being used in your area. The scanner is preprogrammed with all the frequencies allocated to these services. To use this feature, press **SVC**. **SVC** appears and the scanner searches through the weather service band. To select a different service bank, press the desired service bank key (**WX1**, **HAM2**, **MRN3**, **AIR4**, or **POL5**). The corresponding service band number (**-1-**, **-2-**, **-3-**, **-4-**, or **-5-**) appears, and the scanner starts searching the band.

When the scanner stops on a transmission, quickly press either:

- **HOLD** to stop searching so you can listen to the transmission. **HOLD** appears.
- **MON/CLEAR** to store the displayed frequency into the current monitor memory.

To release hold and continue searching, press **HOLD** or hold down t or s for at least 1 second. Or, if you did not press **HOLD**, simply press t or s to continue searching.

Note: Because there are many different frequencies allocated to fire and police departments, it takes several minutes to search all these frequencies.

Search Skip Memory

You can skip up to 20 specified frequencies during a limit or direct search and up to 20 specified frequencies during a service bank search. This lets you avoid unwanted frequencies or ones you have already stored in a channel.

To skip a frequency, press **S/S** when the scanner stops on the frequency during a limit, direct, or service search. The scanner stores the frequency in memory and automatically resumes the search.

A diagram of the scanner's control panel. It shows several buttons: LIMIT, DATA, 1-30, SRC, 1, 91-120, PRIORITY, L-OUT, 4, H/S, S/S, KEY LOCK, 7, HAM, and MON/CLEAR. A large black arrow points from the left towards the S/S button.

To clear a single frequency from skip memory so the scanner once again stops on it during a limit, direct, or service bank search:

1. Press **HOLD** to hold the search.
2. Press t or s to select the frequency. **L/O** appears.
3. Press **S/S**. **L/O** disappears.

To clear all the skip frequencies at once while searching, press **HOLD**, then hold down **S/S** until the scanner beeps twice (about 3 seconds).

Notes:

- If you marked all frequencies to be skipped within the search range, the scanner beeps 3 times and does not search.
- If you program more than 20 frequencies to skip, each new frequency replaces one you already stored, starting from the first frequency you stored.
- Press **t** or **s** to select a skipped frequency while **HOLD** appears. **L/O** appears when you select a skipped frequency.

LISTENING TO THE MONITOR MEMORIES

You can listen to the frequency you stored in any one of the five monitor memories by pressing

MAN then the number of the monitor memory you want to listen to (1-5).

Note: To listen to the monitor memories, the priority channel feature must be turned off (see "Priority" on Page 34).

MOVING A FREQUENCY FROM A MONITOR MEMORY TO A CHANNEL

1. Press **MAN**. **MAN** appears.

2. Enter the number of the channel where you want to store the frequency in a monitor memory, then press **PROG**.

-
3. Press **MON/CLEAR** and enter the number of the monitor memory that contains the frequency you want to store.
 4. Press **E**. The scanner stores the frequency into the selected channel.

SCANNING THE STORED CHANNELS

To begin scanning channels, press **SCAN**. The scanner scans through all non-locked channels in the activated banks. (See “Locking Out Channels” on Page 34 and “Turning Channel-Storage Banks On and Off” on Page 33). When the scanner finds a transmission, it stops on it. When the transmission ends, the scanner resumes scanning.

Notes:

- If you have not stored frequencies into any channels, the scanner does not scan.
- If the scanner picks up unwanted, partial, or very weak transmissions, turn **SQUELCH** clockwise to decrease the scanner's sensitivity to these signals. If you want to listen to a weak or distant station, turn **SQUELCH** counterclockwise.
- If **SQUELCH** is adjusted so you always hear a hissing sound, the scanner does not scan properly.
- To scan in the trunk tracking mode, see “Scanning a Trunked Bank” on Page 43.

MANUALLY SELECTING A CHANNEL

You can continuously monitor a single channel without scanning. This is useful if you hear an emergency broadcast on a channel and do not want to miss any details — even though there might be periods of silence — or if you want to monitor a specific channel.

Follow these steps to manually select a channel.

1. Press **MAN**.
2. Enter the channel number.
3. Press **MAN** again.

Or, if your scanner is scanning and stops at the desired channel, press **MAN** one time. (Pressing **MAN** additional times causes your scanner to step through the channels.)

To resume automatic scanning, press **SCAN**.

SPECIAL FEATURES

DELAY

Many agencies use a two-way radio system that might have a period of 2 or more seconds between a query and a reply. To keep from missing a reply on a specific channel, you can program a 2-second delay into any channel or frequency. The scanner continues to monitor the channel frequency for 2 seconds after the transmission stops before resuming scanning or searching.

To program a 2-second delay:

- If the scanner is scanning and stops

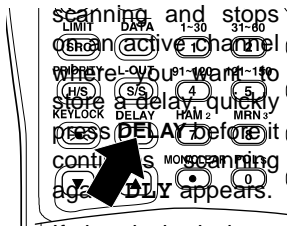

- If the desired channel is not selected, manually select the channel, then press **DELAY**. **DLY** appears.
- If the scanner is searching, press **DELAY** while the scanner is searching. **DLY** appears and the scanner automatically adds a 2-second delay to every frequency it stops on in that band.

To turn off the 2-second delay, press **DELAY** while the scanner is monitoring a channel, scanning, or searching. **DLY** disappears.

TURNING CHANNEL-STORAGE BANKS ON AND OFF

You can turn each channel-storage bank on and off. When you turn off a bank, the scanner does not scan any of the 30 channels in that bank.

While scanning, press the number key that corresponds to the bank you want to turn on or off. Numbers appear at the top of the display, showing the currently selected banks.

The scanner scans all the channels within the displayed banks that are not locked out (see “Locking Out Channels”).

Notes:

- You can manually select any channel within a bank, even if that bank is turned off.
- You cannot turn off all banks. One bank must always be active.

LOCKING OUT CHANNELS

You can increase the scanning speed by locking out channels that have a continuous transmission, such as a weather channel. To lock out a channel, manually select the channel, then press **L-OUT**. **L/O** appears.

Note: You can still manually select locked out channels.

To remove the lockout from a channel, manually select the channel, then press **S/S**. **L/O** disappears.

To unlock all channels in the banks that are turned on, press **MAN** to stop scanning, then hold down **L-OUT** until the scanner beeps twice.

PRIORITY

The priority feature lets you scan through channels and still not miss important or interesting calls on specific channels. You can program one stored channel in each bank as a priority channel (for up to a total of 5 stored channels). If the priority feature is turned on, as the scanner scans the bank, it checks that bank's priority channel every 2 seconds for activity.

The scanner automatically designates each bank's first channel as its priority channel. Follow these steps to select a different channel in a bank as the priority channel.

1. Press **PROG**.
2. Enter the channel number you want to select as the priority channel, then press **PRIORITY**. **P** appears to the right of the channel number.

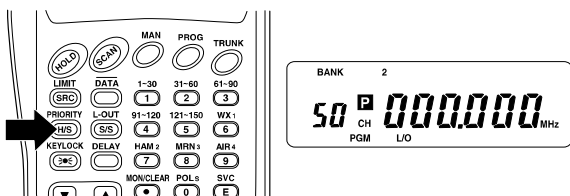

3. Repeat Steps 1 and 2 for the channel in each bank you want to program as a priority channel.

To review all priority channels, press **PROG**, then repeatedly press **PRIORITY** to see the numbers of the priority channels.

To turn on the priority feature, press **PRIORITY** during scanning. **PRI** appears. Every 2 seconds the scanner checks the priority channel in each bank that is turned on.

To turn off the priority feature, press **PRIORITY**. **PRI** disappears.

Notes:

- The priority feature must be turned off to listen to the monitor memories or to use the data skip feature.
- You can lock out priority channels. If you lock out all priority channels, **LOC OUT** appears when you turn on the priority feature.

USING THE KEYSLOCK

Once you program your scanner, you can protect it from accidental program changes by turning on the keylock feature. When locked, the only controls that operate are **SCAN**, **MAN**, **KEYLOCK**, **VOLUME/OFF**, and **SQUELCH**.

Note: The keylock does not prevent the scanner from scanning channels.

To turn on the keylock, hold down **KEYLOCK** until **K/L** appears. To turn it off, hold down **KEYLOCK** until **K/L** disappears.

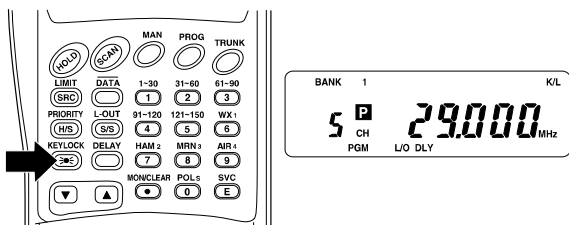

USING THE DISPLAY BACKLIGHT

You can turn on the display light for easy viewing at night. Press $\Rightarrow \bullet \Leftarrow$ to turn on the display light for 15 seconds. To turn off the light before 15 seconds elapse, press the button again.

CHANGING SEARCH SPEEDS

The PRO-91 has two search speeds.

Normal Search	Hypersearch
100 steps/second	300 steps/second

To switch between the normal and Hypersearch speeds during limit search or direct search, press **H/S**. **HYPER** appears during Hypersearch.

Note: You can use Hypersearch only in the 5 kHz step bands (29–54 MHz and 137–174 MHz).

TURNING THE KEY TONE OFF/ON

To turn off the key tone, follow these steps.

1. Turn off the scanner.
2. While holding down **L-OUT/S/S**, turn on the scanner. **OFF bEEP** appears.

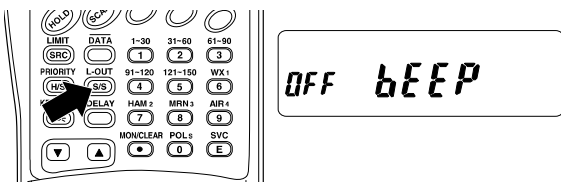

To turn the key tone back on, repeat these steps. **on bEEP** appears.

TURNING THE BATTERY SAVE FUNCTION OFF/ON

To save battery power when a channel is manually selected or while you program the scanner, the scanner automatically sets itself to a standby (battery save) mode if no button is pressed for more than 5 seconds and no signal is received. **s** appears when battery save is set to on.

While the battery save mode is set to on, the scanner repeatedly turns off the internal power for 1 second, then turns it back on for about $1/2$ second to check for a transmission.

The scanner is preset with the battery save mode set to on, but you can turn it off or back on.

Note: The battery save mode does not work if the priority function is on, even if a channel is manually selected.

To turn the battery save function off or back on, turn off the scanner, then hold down **PRIORITY** and turn on the scanner.

- **OFF SAVE** briefly appears when battery save has been turned off.
- **on SAVE** briefly appears when battery save has been turned on.

SKIPPING DATA SIGNALS

You can set the scanner so it skips nonmodulated or data signals (such as fax or modem transmissions) during a search or scan.

Note: Since data signals are not generally found in the air band, this feature does not work in the air band.

To turn on the data skip feature, be sure the priority feature is turned off (see “Priority” on Page 34), then press **DATA**. **DATA** appears. To turn off the feature, press **DATA** again. **DATA** disappears.

TRUNK TRACKING

Your scanner is designed to track transmissions on Motorola Type I, Type II, and hybrid analog trunking systems, which are extensively used in 800 MHz communications. Remember these important points when tracking transmissions:

- Your scanner monitors Type II systems by default. However, you can change this if the system in your area is different (see “Types of Trunking Systems” below and “Scanning Type I and Hybrid Trunked Systems” on Page 50 for more information).
- Your scanner cannot track transmissions on non-Motorola trunking systems.
- Your scanner cannot track an 800 MHz trunked system and scan conventional frequencies at the same time.
- The frequencies for many of the 800 MHz public safety systems are listed in the separate “National Public Safety Trunked System Frequency Guide” included with your PRO-91.

TYPES OF TRUNKING SYSTEMS

Your trunk tracking scanner can monitor two basic types of systems — *Type I* and *Type II*. Instead of selecting a specific frequency to transmit on, a trunked system chooses one of several frequencies in a 2-way radio user’s talk group when that user presses PTT (push to talk). Thus, trunking systems allocate a few frequencies among many different users, but the way Type I and Type II systems do this is slightly different. One important distinction between these systems is the amount of data transmitted by each radio when its push-to-talk (PTT) button is pressed. In a Type I system, the radio’s ID and its current affiliation (the trunk system it belongs to) are both transmitted. In a Type II system, only the radio’s ID is transmitted.

Why the difference? In Type I systems, each radio in the trunk group individually transmits its own affiliation, while the trunk system maintains a database that determines each radio’s affiliation(s) in Type II systems.

Another difference between the systems is that Type I systems are arranged in a fleet-subfleet hierarchy. For example, it is possible for a city using a Type I system to designate 4 fleets, each with 8 subfleets.

The fleets might be the police department, the fire department, utilities, and city administration. The police might decide to further divide its fleet into subfleets such as dispatch, tactical operations, detectives, north, south, east and west side patrols, and supervisors. All the available police radios would then be assigned to one of the police subfleets, letting the police centralize their communications and control the type of users on a single system. Determining the exact fleet-subfleet hierarchy for a particular area is referred to as fleet map programming.

The disadvantage of a Type I system is that the brief burst of data sent when a user transmits must contain the radio's ID and its fleet and subfleet. This is three times the amount of data a Type II system radio sends. Since the data capacity of Type I systems is limited and the amount of data increases with each user, Type I systems usually accommodate fewer users than Type II systems. Nevertheless, Type I systems are still in use.

There are also *hybrid* systems which are a combination of both Type I and Type II. Your scanner defaults to monitor Type II systems, but you can change to Type I or a hybrid of Type I and Type II systems by selecting a preprogrammed fleet map or creating a custom fleet map for your area (see "Scanning Type I and Hybrid Trunked Systems" on Page 50).

You do not need to determine the fleet-subfleet hierarchy for Type II systems unless you are tracking hybrid systems that contain both Type I and Type II systems.

SETTING THE SCANNER TO THE TRUNK TRACKING MODE

Press **TRUNK** to switch between conventional scanning and trunk tracking.

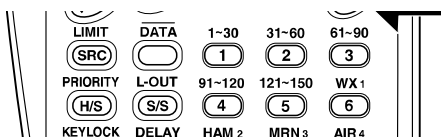

SETTING SQUELCH FOR THE TRUNK TRACKING MODE

Your scanner's squelch setting is automatically adjusted during trunk tracking, which means it is not necessary to manually adjust squelch while tracking trunked transmissions. However, the squelch setting can affect how fast your scanner acquires the data channel, and, in some instances, can prevent your scanner from acquiring the data channel at all.

We recommend you set **SQUELCH** to this position before selecting a trunked bank.

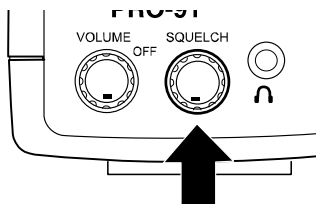

Note: You can change this setting, if necessary, to provide better performance in your area.

STORING TRUNKED FREQUENCIES

Before you set up your scanner to track a trunked system, consider the following:

- Valid trunked system frequencies range from 851.0000–868.9875 in 12.5 kHz steps.
- You can use any of your scanner's banks as either a trunk tracking bank or conventional scanning bank, but you cannot mix the two.
- The scanner only scans one trunked system at a time. Although you can store frequencies for more than one trunked system in one of your scanner's banks, the scanner only scans the frequencies associated with the first data channel it finds.

Before scanning a trunked system's transmissions, you must store the trunked system's frequencies in one of the banks in your scanner by following these steps.

1. Press **PROG** then **TRUNK**. **TRUNK** appears and one or more bank numbers flash.

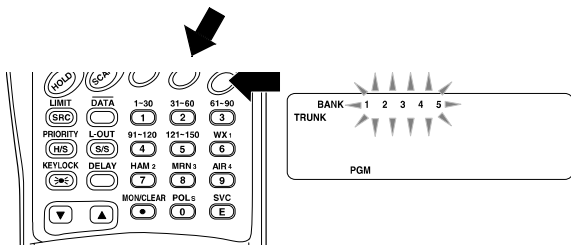

2. Select the bank you want to store the trunked system's frequencies in by pressing a number key. The scanner automatically selects the first channel in the bank when you select the bank.
3. Use the number keys to enter one of the trunked system's frequencies, then press **E**. **TRUNK**, **BANK** and the bank number, the channel number, and the frequency appear.

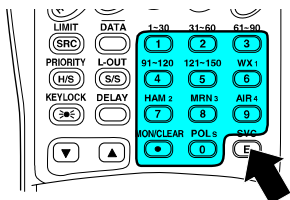

Note: If you entered an invalid frequency, the scanner beeps, the channel number flashes and **Error** appears. If this happens, press **•** to clear the frequency, then repeat this step.

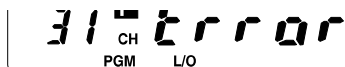

4. Press either **PROG** or **s** to select the next channel in the bank.
5. Repeat Steps 3 and 4 until all frequencies have been entered in that bank.

- Press **SRC** to begin searching for the trunk's data channel (the channel that controls the trunk). **SEARCH** flashes as the scanner searches for the data channel.

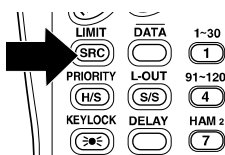

While the scanner looks through the frequencies, you see them on the display. When the scanner finds the data channel, it begins trunk tracking.

SCANNING A TRUNKED BANK

You can scan one trunked bank at a time. Once you have stored frequencies for a trunked system in one or more of the 5 available banks and you are scanning conventional (non-trunked) frequencies, follow these steps to begin trunk scanning.

- Press **TRUNK**. The numbers for all banks flash, along with **BANK** and **TRUNK**.

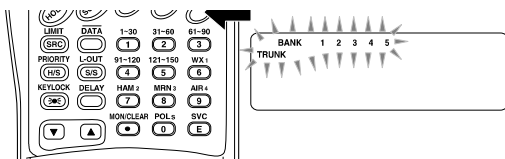

- Use the number keys to enter the number for the trunked bank you want to scan, then press **SRC**. The scanner searches for a data channel. When the scanner finds it, it begins trunk tracking.

If you entered all of the trunk's frequencies, you should be able to follow conversations between broadcasters even when they change frequencies. IDs, which represent different service groups, appear.

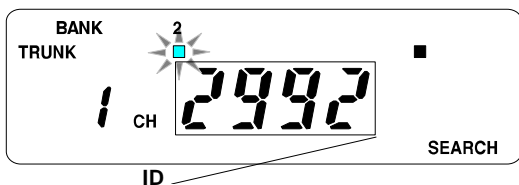

- To return to conventional scanning, press **TRUNK** again.

Hint: While scanning, you will not know exactly who the IDs are assigned to until you listen awhile or until you locate ID lists in frequency guides or on internet sites such as *www.trunkscanner.com*. Within a few minutes, you can usually figure out if what you are listening to is a police, fire, or emergency medical 2-way radio user. Other IDs might take some time, but determining who each ID represents is half the fun of trunk tracking!

Monitoring an Active ID

When the scanner stops on a transmission, you can hold the scanner on that transmission.

1. Press **HOLD**. **HOLD** appears and the scanner stays on the current ID.

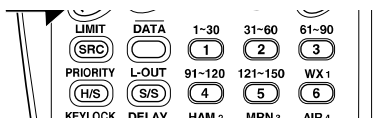

2. If you want to listen to a different ID, use the number keys to enter the ID you want to hold.
3. Press **HOLD** again. **HOLD** and the channel number flash and the scanner monitors that ID.
4. When you want to stop the hold and resume searching for a data channel so you can continue trunk tracking, press **SRC**.

Note: You can also follow these steps to hold on an ID while scanning a scan list. See “Scan Lists” on Page 48.

Temporarily Storing an ID into the Monitor ID Memory

1. When your scanner stops on an ID you want to store, press **MON/CLEAR**. The scanner stores the ID into the monitor ID memory.
2. Press **SRC** to resume searching.

Note: To program the ID stored in the monitor ID memory into the ID scan list, see “Scan Lists” on Page 48.

Locking Out IDs

As with conventional scanning, it is possible to lock out unwanted traffic. This is particularly important in trunked systems because signals you cannot listen to (such as water meters, door alarms, traffic signals, and encrypted signals) are assigned IDs just like other users. You can have up to 100 IDs locked out at one time.

Note: If you lock out an ID while searching, it is also locked out of the scan list(s). See “Scan Lists” on Page 48.

To lock out an ID, press **L-OUT** when the ID appears.

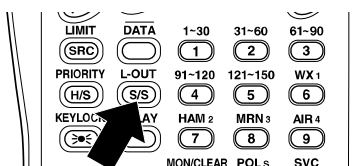

The ID is locked out, and the next active ID appears.

Unlocking a Single ID

1. Hold down **L-OUT** until you hear two short beeps.
2. Repeatedly press **t** or **s** to select the ID you want to unlock.
3. Press **L-OUT**.

The ID is unlocked, and the next locked ID or **-- ---** (if there are no other locked IDs) appears.

4. Press **SRC** to continue the scanner’s previous function.

Unlocking All IDs

Hold down **L-OUT** until you hear two short beeps. Then press **E** to unlock all the IDs at once. The scanner beeps twice.

Note: When you unlock all the IDs, the scan list appears. Press **SCAN** to scan the IDs stored in your scan lists or press **SRC** to continue the scanner’s previous function. For more information about scan lists, see “Scan Lists” on Page 48.

Using Trunk Tracking Scan Delay

Many trunked systems have a period of 2 or more seconds between a query and a reply. You can program a 5-second delay to hold on an ID for 5 seconds to wait for a reply. The scanner continues to monitor the frequency for 5 seconds after the transmission stops before resuming scanning.

Press **DELAY** to turn trunk tracking scan delay on or off. **DLY** appears when trunk tracking scan delay is set.

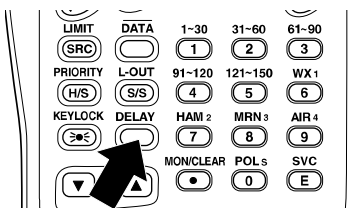

Note: If you consistently miss responses even with trunk tracking scan delay set, you might need to change the default system type or the fleet map you are using. See “Scanning Type I and Hybrid Trunked Systems” on Page 50.

Monitoring IDs

You can use your scanner's display to monitor the frequencies in a trunked system for activity. You cannot hear conversations in this mode, but this is an excellent way to determine which talk groups are the most active. To set the scanner to monitor IDs, hold down **MON/CLEAR** until **SEARCH** and the channel number flash, and all active talk group IDs appear in quick succession. To stop monitoring IDs, press **SRC** again.

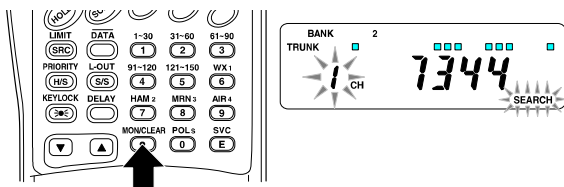

Note: When you monitor IDs, locked-out IDs also appear.

CHANNEL ACTIVITY BARS

Your scanner has 20 channel activity indicators (bars) which show the activity taking place on a trunked system. You can see how many frequencies are being used and generally monitor how much communication traffic is occurring.

Each frequency you store in a trunking bank has a corresponding activity bar. However, since there are only 20 bars, but you can store up to 30 frequencies, some bars might indicate more than one frequency if the trunked system you are scanning has more than 20 channels.

- The bar that remains on steadily even when there are no current transmissions represents the frequency being used as the data channel.

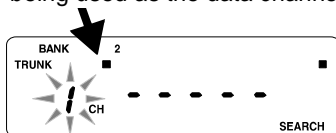

- The bar that flashes when an ID appears represents the frequency being used by the radio to transmit what you are currently hearing.



- If a bar turns on but you do not hear a conversation, the channel is probably being used for a telephone interconnect call or a private call, or the bar might be a locked-out ID. Your scanner does not monitor these types of calls.

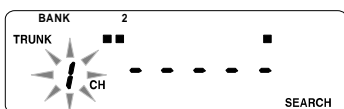

- If the scanner is holding on an ID which is not active, the other activity bars turn on and off as other groups use the system.



SCAN LISTS

When you program trunked frequencies into a bank (see “Storing Trunked Frequencies” on Page 41), your scanner sets up 5 scan lists into which you can store your favorite IDs. Each list can contain up to 10 IDs, so you can store a total of 50 IDs for each trunk tracking bank (250 IDs if you use all banks as trunking banks!). Scan lists help you organize trunking system users into categories. For example, you might use List 1 for police IDs, List 2 for fire department IDs, List 3 for emergency medical service IDs, and so on. Once IDs are stored in lists, you can scan them like you scan conventional channels. You can program IDs into scan lists manually, during a search, or automatically.

Manually Storing IDs into Scan Lists

1. Select the trunking bank you want (see “Scanning a Trunked Bank” on Page 43).
2. After the scanner begins trunk tracking, press **MAN**. A number showing the current scan list appears steadily at the top of the display, and bars which show activity in other banks appear.

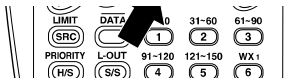

3. Press **MAN** then repeatedly press **s** or **t** to select the ID scan list location (shown at the top of the display) where you want to store an ID. Then, press **PROG** to select the ID you want to store.

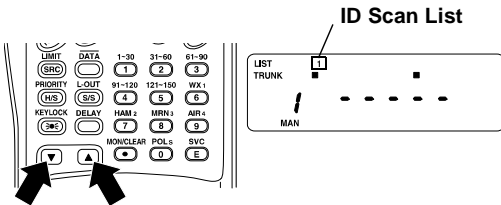

4. Enter the Type II ID you want to store, then press **E**.

Or, to enter a Type I ID:

- a. Use the number keys to enter the block number and fleet number, then press **●**.
- b. Enter the subfleet number, then press **E**.

Note: To clear a mistake while entering an ID, press **0** then **E**, then start over at Step 1.

5. Repeatedly press **PROG** or **s** to select the next scan list location you want to program. Then repeat Step 4 to enter another ID.

Moving IDs to Scan Lists

1. Press **MAN**. **MAN** appears.
2. Select the ID scan list location where you want to store the IDs. Then press **PROG**. **PGM** appears.
3. Press **MON/CLEAR**. A monitor ID appears.
4. Press **E**. The scanner stores the IDs into the selected ID scan lists.

Deleting a Stored ID

1. Press **PROG**. **PGM** appears.
2. Repeatedly press **s** or **t** to select the scan list location (shown at the top of the display) you want to delete.
3. Press **0** then **E**.

SCANNING THE SCAN LISTS

Press **SCAN** to begin scanning the lists you have stored.

Note: If you have not stored any IDs, **SCAN** scrolls on the display, but your scanner does not stop on an active conversation.

To remove a scan list from active scanning, use the number keys to enter the scan list's number. The scan list number turns off, and the IDs in that list are not scanned.

Note: One scan list must always be active. You cannot remove all of the scan lists.

To restore a scan list to active scanning, use the number keys to enter its number again.

Press **SRC** to return to the scanner's previous function.

SCANNING TYPE I AND HYBRID TRUNKED SYSTEMS

Your PRO-91 is set to scan Type II user IDs by default. When you scan trunked frequencies, each Type II user ID you see appears as an even number without a dash (such as 2160). Your PRO-91 can also scan Type I trunked systems. Each Type I ID appears as a three- or four-digit number, followed by a hyphen, followed by a one- or two-digit number (such as 200-14). If you notice a mix of odd- and even-user IDs (such as 6477, 2160, 6481, 6144, and 1167), then you are probably monitoring either a Type I or hybrid (a combination of Type I and Type II user IDs) system (see "Types of Trunking Systems" on Page 39).

You might also notice that you are missing responses when you hold on an active ID. Unlike Type II systems, Type I and hybrid systems require a fleet map that sets specific fleet-subfleet parameters. It is easy to select a fleet map to scan; what is not always easy is selecting or programming a map that is being used in your particular area.

4. Press **DATA** again.
5. Repeatedly press **s** or **t** to select the name of the map you want (such as **E1P7**). The preprogrammed fleet map appears.
6. Press **E**, then **SRC**. The scanner then searches for transmissions using the preset map you chose.

Note: When the scanner searches for transmissions, you see Type I fleet and subfleet IDs such as **100-12**, **100-9**, **000-12**, or **400-8**.

How do you know if the preset map you selected is correct? Listen to see if you are following complete conversations. If not, try another preset map.

Programming a Fleet Map

1. Set the scanner for conventional scanning, press **PROG**, then press **TRUNK**.
2. Select the bank where you want to program the fleet map by pressing a number key.
3. Press **DATA**.
4. Repeatedly press **s** or **t** to select **E1**, then press **DATA**. A preprogrammed fleet map appears.
5. Repeatedly press **s** or **t** until **USr** appears. Then press **E**.

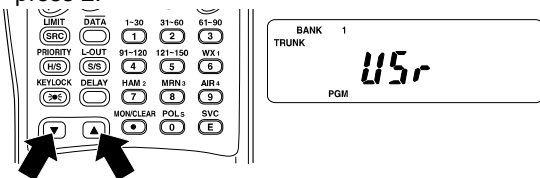

6. Press **DATA**.
7. Repeatedly press **s** or **t** to select the size code for the first block, then press **E**. The next available block appears.

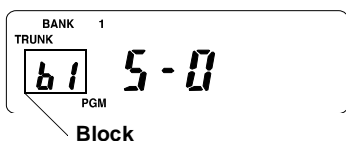

8. Repeat Step 7 until you have selected a size code for each block you want to work with.

When a Type I system is designed, the address information for all its user IDs is divided into 8 equal-size blocks, numbered 0–7, and each block is assigned a size code. When you set up your scanner to track a Type I system, you must choose a size code for each block. When you have chosen a size code for all 8 blocks, you will have duplicated the *fleet map* for the system you are tracking. If you have chosen correctly, you will be able to track transmissions in that system.

Each size code defines the number of fleets, subfleets, and IDs each block has. For example, you can see in the following table that a size code of S-4 has one fleet, which is divided into 16 separate subfleets, and it has a total of 512 individual IDs.

Size	Fleets	Subfleets	IDs	Blocks Used
S-0	Reserved block for Type II IDs			
S-1	128	4	16	1
S-2	16	8	64	1
S-3	8	8	128	1
S-4	1	16	512	1
S-5	64	4	32	1
S-6	32	8	32	1
S-7	32	4	64	1
S-8	16	4	128	1
S-9	8	4	256	1
S-10	4	8	256	1
S-11	2	16	256	1
S-12	1	16	1024	2
S-13	1	16	2048	4
S-14	1	16	4096	8

Each ID in the block is unique. The left-most digit is the block number in the ID. The next two digits identify which fleet is active, and the last digit(s) (after the hyphen) identifies the subfleet.

The size codes selected by a Type I system designer depend on the specific needs of the system's users. Some organizations might want many subfleets with only a few radios each, while another organization might want only a few subfleets, with many radios each. To scan Type I systems, you must select or program a fleet map with the same size code assignments as the trunked system. If you do this accurately, you will track all the fleet and subfleet combinations used by the system. In other words, you will hear complete communications while monitoring a trunked system.

Note: Preset fleet maps might be available at www.trunkscanner.com.

If you do not already know the size codes used, you will have to guess them. But since you do not have to figure out all the blocks at once, this is not as hard as it seems. Select a size code for a block, then press **SRC**. Now listen to the communications. If you decide you are receiving most of the replies to the conversations with IDs assigned to the block you just programmed, then you have probably selected the right size code and can work on the next block of the map.

There are 16 preset fleet maps to choose from, and it is best to start with these when setting up a Type I or hybrid trunk tracking bank. If none of the following preset fleet maps allow you to follow complete conversations, then you probably need to program your own fleet map (see "Programming a Fleet Map" on Page 51).

E1P1		E1P2		E1P3	
Block	Size Code	Block	Size Code	Block	Size Code
0	S11	0	S4	0	S4
1	S11	1	S4	1	S4
2	S11	2	S4	2	S4
3	S11	3	S4	3	S4
4	S11	4	S4	4	S4
5	S11	5	S4	5	S4
6	S11	6	S4	6	S12
7	S11	7	S4	7	(S12)

E1P4		E1P5		E1P6	
Block	Size Code	Block	Size Code	Block	Size Code
0	S12	0	S4	0	S3
1	(S12)	1	S4	1	S10
2	S4	2	S12	2	S4
3	S4	3	(S12)	3	S4
4	S4	4	S4	4	S12
5	S4	5	S4	5	(S12)
6	S4	6	S4	6	S12
7	S4	7	S4	7	(S12)

E1P7		E1P8		E1P9	
Block	Size Code	Block	Size Code	Block	Size Code
0	S10	0	S1	0	S4
1	S10	1	S1	1	S4
2	S11	2	S2	2	S0
3	S4	3	S2	3	S0
4	S4	4	S3	4	S0
5	S4	5	S3	5	S0
6	S4	6	S4	6	S0
7	S4	7	S4	7	S0

E1P10		E1P11		E1P12	
Block	Size Code	Block	Size Code	Block	Size Code
0	S0	0	S4	0	S0
1	S0	1	S0	1	S0
2	S0	2	S0	2	S0
3	S0	3	S0	3	S0
4	S0	4	S0	4	S0
5	S0	5	S0	5	S0
6	S4	6	S0	6	S0
7	S4	7	S0	7	S4

E1P13		E1P14	
Block	Size Code	Block	Size Code
0	S3	0	S4
1	S3	1	S3
2	S11	2	S10
3	S4	3	S4
4	S4	4	S4
5	S0	5	S4
6	S0	6	S12
7	S0	7	S12

E1P15		E1P16	
Block	Size Code	Block	Size Code
0	S4	0	S3
1	S4	1	S10
2	S4	2	S10
3	S11	3	S11
4	S11	4	S0
5	S0	5	S0
6	S12	6	S12
7	S12	7	S12

Selecting a Preset Fleet Map

1. Set the scanner for conventional scanning, press **PROG**, then press **TRUNK**.
2. Select the bank where you want to store the preset fleet map by pressing a number key.
3. Press **DATA**.

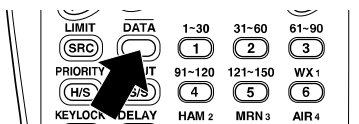

4. Repeatedly press s or t to select **E1**. Then, when **E1** flashes, press **E**.

-
-
9. Press **SRC**. The scanner exits the trunking programming mode, tunes the data channel, then begins to search using the map you programmed.

Note: If you select size code S-12, S-13, or S-14, these restrictions apply:

- S-12 can only be assigned to Blocks 0, 2, 4, or 6.
- S-13 can only be assigned to Blocks 0 and 4.
- S-14 can only be assigned to Block 0.

Since these size codes require multiple blocks, you will be prompted for the next available block when programming a fleet map. For example, if you assign Block 0 as an S-12, the scanner prompts you for **b2**, the next block available, instead of b1. And if you assign Block 0 as an S-14, you would not see another prompt because it uses all available blocks.

Programming a Hybrid System

A hybrid system is simply a Type I system with some of its blocks designated as Type II blocks. To program a hybrid system, follow the steps listed in “Programming a Fleet Map” on Page 51. However, if you want a block to be Type II, select size code **S-0** in Step 7.

A GENERAL GUIDE TO SCANNING

Reception of the frequencies covered by your scanner is mainly "line-of-sight." That means you usually cannot hear stations that are beyond the horizon.

GUIDE TO FREQUENCIES

National Weather Frequencies

162.400	162.475	162.525
162.425	162.500	162.550
162.450		

Canadian Weather Frequencies

161.650	161.775	163.275
---------	---------	---------

Note: These frequencies are not preprogrammed in the weather service bank but can be manually programmed into a channel.

Birdie Frequencies

Every scanner has birdie frequencies. Birdies are signals created inside the scanner's receiver. These operating frequencies might interfere with broadcasts on the same frequencies. If you program one of these frequencies, you hear only noise on that frequency. If the interference is not severe, you might be able to turn **SQUELCH** clockwise to cut out the birdie.

This scanner's birdie frequencies (in MHz) are:

31.2000	41.6000	52.0000	138.7100
138.7150	145.6000	148.6200	165.3000
171.2500	406.2250	407.7625	407.8125
413.1750	413.2250	416.1375	426.0375
426.0500	435.9500	455.7625	455.8625
455.7750	465.6750	475.5875	485.4875
489.2500	495.4000	505.3000	505.3125
813.4000	820.9500	822.3625	899.2375

GUIDE TO THE ACTION BANDS

Typical Band Usage

VHF Band

Low Range	29.00–50.00 MHz
6-Meter Amateur	50.00–54.00 MHz
U.S. Government	137.00–144.00 MHz
2-Meter Amateur	144.00–148.00 MHz
High Range	148.00–174.00 MHz

UHF Band

U.S. Government	406.00–420.00 MHz
70-cm Amateur	420.00–450.00 MHz
Low Range	450.00–470.00 MHz
FM-TV Audio Broadcast, Wide Band	470.00–512.00 MHz
Public Service	806.00–823.93 MHz
Conventional Systems	851.00–856.00 MHz
Conventional/Trunked Systems	856.00–861.00 MHz
Trunked Systems	861.00–866.00 MHz
Public Safety	866.00–868.93 MHz
High Range	896.11–902.00 MHz
33-Centimeter Amateur	902.00–928.00 MHz
Private Trunked	935.00–940.00 MHz
General Trunked	940.00–941.00 MHz
Fixed Services	941.00–944.00 MHz
Studio-to-Transmitter Broadcast Links	944.00–952.00 MHz
Private Fixed Services, Paging	952.00–956.00 MHz

Primary Usage

As a general rule, most of the radio activity is concentrated on the following frequencies:

VHF Band

Activities	Frequencies
Government, Police, and Fire	153.785–155.980 MHz
Emergency Services	158.730–159.460 MHz
Railroad	160.000–161.900 MHz

UHF Band

Activities	Frequencies
Land-Mobile "Paired" Frequencies	450.000–470.000 MHz
Base Stations	451.025–454.950 MHz
Mobile Units	456.025–459.950 MHz
Repeater Units	460.025–464.975 MHz
Control Stations	465.025–469.975 MHz

Note: Remote control stations and mobile units operate at 5 MHz higher than their associated base stations and relay repeater units.

BAND ALLOCATION

To help decide which frequency ranges to scan, use the following listing of the typical services that use the frequencies your scanner receives. These frequencies are subject to change, and might vary from area to area. For a more complete listing, refer to the "Police Call Radio Guide including Fire and Emergency Services," available at your local RadioShack store.

Abbreviations

Services

BIFC	Boise (ID) Interagency Fire Cache
BUS	Business
CAP	Civil Air Patrol
CB	Citizens Band
CCA	Common Carrier
CSB	Conventional Systems
CTSB	Conventional/Trunked Systems
FIRE	Fire Department
HAM	Amateur (Ham) Radio
GOVT	Federal Government
GMR	General Mobile Radio
GTR	General Trunked
IND	Industrial Services
	(Manufacturing, Construction, Farming, Forest Products)
MAR	Military Amateur Radio
MARI	Maritime Limited Coast
	(Coast Guard, Marine Telephone, Shipboard Radio, Private Stations)
MARS	Military Affiliate Radio System
MED	Emergency/Medical Services
MIL	U.S. Military
MOV	Motion Picture/Video Industry
NEW	New Mobile Narrow
NEWS	Relay Press (Newspaper Reporters)
OIL	Oil/Petroleum Industry
POL	Police Department
PUB	Public Services
	(Public Safety, Local Government, Forestry Conservation)
PSB	Public Safety
PTR	Private Trunked

ROAD	Road & Highway Maintenance
RTV	Radio/TV Remote Broadcast Pickup
TAXI	Taxi Services
TELB.	Mobile Telephone
	(Aircraft, Radio Common Carrier, Landline Companies)
TELC.	Cordless Phones
TELM	Telephone Maintenance
TOW	Tow Trucks
TRAN	Transportation Services
	(Trucks, Tow Trucks, Buses, Railroad, Other)
TSB.	Trunked Systems
TVn	FM-TV Audio Broadcast
USXX	Government Classified
UTIL	Power & Water Utilities
WTHR	Weather

VERY HIGH FREQUENCY (VHF)

VHF Low Band—(29–50 MHz—in 5 kHz steps)

29.000–29.700	HAM
29.900–30.550	GOVT, MIL
30.580–31.980	IND, PUB
32.000–32.990	GOVT, MIL
33.020–33.980	BUS, IND, PUB
34.010–34.990	GOVT, MIL
35.020–35.980	BUS, PUB, IND, TELM
36.000–36.230	GOVT, MIL
36.250	Oil Spill Cleanup
36.270–36.990	GOVT, MIL
37.020–37.980	PUB, IND
38.000–39.000	GOVT, MIL
39.020–39.980	PUB
40.000–42.000	GOVT, MIL, MARI
42.020–42.940	POL
42.960–43.180	IND
43.220–43.680	TELM, IND, PUB
43.700–44.600	TRAN
44.620–46.580	POL, PUB
46.600–46.990	GOVT, TELC
47.020–47.400	PUB
47.420	American Red Cross
47.440–49.580	IND, PUB
49.610–49.990	MIL, TELC

6-Meter Amateur Band—(50–54 MHz)

50.00–54.00	HAM
-------------	-----

Aircraft Band—(108–137 MHz)

108.00–121.490	AIR
121.500	AIR Emergency
121.510–136.000	AIR

U.S. Government Band (137–144 MHz)

137.000–144.000	GOVT, MIL
-----------------	-----------

2-Meter Amateur Band (144–148 MHz)

144.000–148.000	HAM
-----------------	-----

VHF High Band (148–174 MHz)

148.050–150.345	CAP, MAR, MIL
150.775–150.790	MED
150.815–150.980	TOW, Oil Spill Cleanup
150.995–151.475	ROAD, POL
151.490–151.955	IND, BUS
151.985	TELM

152.0075	MED
152.030–152.240	TELB
152.270–152.480	IND, TAXI, BUS
152.510–152.840	TELB
152.870–153.020	IND, MOV
153.035–153.725	IND, OIL, UTIL
153.740–154.445	PUB, FIRE
154.490–154.570	IND, BUS
154.585	Oil Spill Cleanup
154.600–154.625	BUS
154.655–156.240	MED, ROAD, POL, PUB
156.255–157.425	OIL, MARI
157.450	MED
157.470–157.515	TOW
157.530–157.725	IND, TAXI
157.740	BUS
157.770–158.100	TELB
158.130–158.460	BUS, IND, OIL, TELM, UTIL
158.490–158.700	TELB
158.730–159.465	POL, PUB, ROAD
159.480	OIL
159.495–161.565	TRAN
161.580–162.000	OIL, MARI, RTV
162.0125–162.35	GOVT, MIL, USXX
162.400–162.550	WTHR
162.5625–162.6375	GOVT, MIL, USXX
162.6625	MED
162.6875–163.225	GOVT, MIL, USXX
163.250	MED
163.275–166.225	GOVT, MIL, USXX
166.250	GOVT, RTV, FIRE
166.275–169.400	GOVT, BIFC
169.445–169.505	Wireless Mikes, GOVT
169.55–169.9875	GOVT, MIL, USXX
170.000–170.150	BIFC, GOVT, RTV, FIRE
170.175–170.225	GOVT
170.245–170.305	Wireless Mikes
170.350–170.400	GOVT, MIL
170.425–170.450	BIFC
170.475	PUB
170.4875–173.175	GOVT, PUB, Wireless Mikes
173.225–173.5375	MOV, NEWS, UTIL, MIL
173.5625–173.5875	MIL Medical/Crash Crews
173.60–173.9875	GOVT

ULTRA HIGH FREQUENCY (UHF)

U. S. Government Band (406–420 MHz)

406.125–419.975 GOVT, USXX

70-cm Amateur Band (420–450 MHz)

420.000–450.000 HAM

Low Band (450–470 MHz)

450.050–450.925	RTV
451.025–452.025	IND, OIL, TELM, UTIL
452.0375–453.00	IND, TAXI, TRAN TOW, NEWS
453.0125–454.000	PUB, OIL
454.025–454.975	TELB
455.050–455.925	RTV
457.525–457.600	BUS
458.025–458.175	MED
460.0125–460.6375	FIRE, POL, PUB
460.650–462.175	BUS
462.1875–462.450	BUS, IND
462.4625–462.525	IND, OIL, TELM, UTIL
462.550–462.925	GMR, BUS

462.9375–463.1875	MED
463.200–467.925	BUS

**FM-TV Audio Broadcast, UHF Wide Band (470–512 MHz)
(Channels 14 through 69 in 6 MHz steps)**

475.750	Channel 14
481.750	Channel 15
487.750	Channel 16
.....
.....
511.750	Channel 20

Note: Some cities use the 470–512 MHz band for land/mobile service.

Conventional Systems Band – Locally Assigned

851.0125–855.9875	.CSB
-------------------	------

Conventional/Trunked Systems Band – Locally Assigned

856.0125–860.9875	.CTSB
-------------------	-------

Trunked Systems Band – Locally Assigned

861.0125–865.9875	.TSB
-------------------	------

Public Safety Band – Locally Assigned

866.0125–868.9875	.PSB
-------------------	------

33-Centimeter Amateur Band (902–928 MHz)

902.0000–928.0000	HAM
-------------------	-----

Private Trunked

935.0125–939.9875	.PTR
-------------------	------

General Trunked

940.0125–940.9875	.GTR
-------------------	------

FREQUENCY CONVERSION

The tuning location of a station can be expressed in frequency (kHz or MHz) or in wavelength (meters). The following information can help you make the necessary conversions.

$$1 \text{ MHz (million)} = 1,000 \text{ kHz (thousand)}$$

To convert MHz to kHz, multiply the number of megahertz by 1,000:

$$9.62 \text{ (MHz)} \times 1000 = 9620 \text{ kHz}$$

To convert from kHz to MHz, divide the number of kilohertz by 1,000:

$$2780 \text{ (kHz)} \div 1000 = 2.780 \text{ MHz}$$

To convert MHz to meters, divide 300 by the number of megahertz:

$$300 \div 7.1 \text{ MHz} = 42.25 \text{ meters}$$

TROUBLESHOOTING

If you have problems, here are some suggestions that might help. If they do not, take your scanner to your local RadioShack store for assistance.

PROBLEM	POSSIBLE CAUSE	REMEDY
Scanner is on but will not scan.	SQUELCH is not adjusted correctly.	Turn SQUELCH clockwise.
	Only one channel or no channels are stored.	Store frequencies into more than one channel.
Scanner is totally inoperative.	No power.	Check the batteries or make sure the AC adapter or DC adapter is connected properly.
		Recharge the rechargeable batteries or replace the non-rechargeable batteries.
	The AC adapter or DC adapter is not connected.	Be sure the adapter's barrel plug is fully plugged into the POWER jack.
The scanner's display dims or the scanner sounds a tone every 15–30 seconds.	Batteries are not correctly installed.	Make sure the batteries are installed properly.
	The batteries are weak.	Recharge the rechargeable batteries or replace the non-rechargeable batteries.
Keypad does not work.	The keylock function is activated.	To turn off the keylock, press KEYLOCK until K/L disappears.
BATT . Lo flashes.	The batteries are weak.	Recharge the rechargeable batteries or replace the non-rechargeable batteries.

PROBLEM	POSSIBLE CAUSE	REMEDY
---------	----------------	--------

PROBLEM	POSSIBLE CAUSE	REMEDY
	An antenna is not connected or connected incorrectly.	Make sure an antenna is connected to the scanner.
Error appears.	Programming error.	Re-enter the frequency correctly, including the decimal point.
The scanner locks on frequencies that have an unclear transmission.	Stored frequencies are the same as "birdie" frequencies.	Avoid storing frequencies listed under "Birdie Frequencies" on Page 57 or only listen to them manually.
Scanner will not track a trunked system.	The transmission might not use a system that can be tracked by your scanner.	Scan another transmission.
	The data frequency is missing.	Find the data frequency (see "Storing Trunked Frequencies" on Page 41).
	The system you are trying to track is a Type I system, and the scanner is set to scan Type II systems.	Set the scanner to receive Type I trunked frequencies. See "Scanning Type I and Hybrid Trunked Systems" on Page 50.

Scanner is set to receive Type I trunked frequencies, but does not scan them.	The fleet map you have selected or entered might be incorrect.	Check the fleet map and correct it if necessary (see "Scanning Type I and Hybrid Trunked Systems" on Page 50 and "Programming a Fleet Map" on Page 51).
---	--	---

PROBLEM	POSSIBLE CAUSE	REMEDY
Scanner will not stop while scanning a scan list.	No IDs have been stored.	Store one or more IDs (see “Scan Lists” on Page 48).
	The IDs you have stored are not active.	Scan another transmission.
Scanner will not acquire a data channel.	SQUELCH is not correctly adjusted for trunk tracking.	Adjust squelch for trunk tracking. See “Setting Squelch for the Trunk Tracking Mode” on Page 41.
	The frequency used for the data channel is missing.	Press SRC to search for the data channel (see “Storing Trunked Frequencies” on Page 41).
Missing replies to conversations.	The system you are trying to track is a Type I system, and the scanner is set to scan Type II systems.	Set the scanner to receive Type I trunked frequencies. See “Scanning Type I and Hybrid Trunked Systems” on Page 50.
	The selected fleet map is incorrect.	Try another preset fleet map or program your own fleet map (see “Scanning Type I and Hybrid Trunked Systems” on Page 50).
Missing replies to conversations (continued)	Not all of the trunk’s frequencies have been entered.	Enter all of the trunk’s frequencies (see “Storing Trunked Frequencies” on Page 41).

PROBLEM	POSSIBLE CAUSE	REMEDY
Channel activity bars are flashing but no sound is heard.	The transmission might be a private or telephone interconnect call. The scanner does not scan these types of transmissions.	Scan for another transmission.
	The ID shown is not active.	Wait for the ID to become active, or scan another transmission.

RESETTING THE SCANNER

If the scanner's display locks up or does not work properly, you might need to reset the scanner.

Caution: This procedure clears all the information you have stored into the scanner. Before you reset the scanner, try turning it off and on to see if it begins working properly. Reset the scanner only when you are sure it is not working properly.

1. Turn off the scanner.
2. While you hold down the **2** and **9** keys, turn on the scanner. **CLEAR** flashes for about 8 seconds as the scanner clears its memory.

Note: Do not turn off the scanner until **CLEAR** stops flashing. Otherwise, the scanner might not clear its memory properly.

CARE AND MAINTENANCE

Your RadioShack PRO-91 150-Channel Handheld Trunking Scanner is an example of superior design and craftsmanship. The following suggestions will help you care for your scanner so you can enjoy it for years.



Keep the scanner dry. If it gets wet, wipe it dry immediately. Liquids can contain minerals that can corrode the electronic circuits.



Use only batteries of the recommended size and type. Always remove old and weak batteries. They can leak chemicals that destroy electronic circuits.



Handle the scanner gently and carefully. Dropping it can damage circuit boards and cases and can cause the scanner to work improperly.



Use and store the scanner only in normal temperature environments. Temperature extremes can shorten the life of electronic devices, damage batteries, and distort or melt plastic parts.



Keep the scanner away from dust and dirt, which can cause premature wear of parts.



Wipe the scanner with a damp cloth occasionally to keep it looking new. Do not use harsh chemicals, cleaning solvents, or strong detergents to clean the scanner.

Modifying or tampering with the scanner's internal components can cause a malfunction, invalidate your scanner's warranty and void your FCC authorization to operate it. If your scanner is not operating as it should, take it to your local RadioShack store for assistance.

SPECIFICATIONS

Frequency Coverage: 29–54 MHz (in 5 kHz steps)
108–136.975 MHz (in 12.5 kHz steps)
137–174 MHz (in 5 kHz steps)
406–512 MHz (in 12.5 kHz steps)
806.0000–823.9375 MHz (in 12.5 kHz steps)
851.0000–868.9875 MHz (in 12.5 kHz steps)
896.1125–956.0000 MHz (in 12.5 kHz steps)

Monitor Channels 5

Number of Banks 5

Sensitivity (AM/FM):

NFM: 20 dB S/N at 3 kHz deviation):

29–54 MHz 0.5 μ V

137–174 MHz 0.4 μ V

406–512 MHz 0.4 μ V

806–956 MHz 0.6 μ V

AM: 20 dB S/N at 60% modulation):

108–136.9875 MHz 1.5 μ V

Spurious Rejection (at 40.84 MHz) 50 dB

Selectivity:

10 kHz –6 dB

15 kHz –50 dB

IF Rejection (at 162.4 MHz) 80 dB

Channels 150

Operating Temperature –4 to 140° F (–20 to 60° C)

Scan Speed 50 Channels/Second

Search Speed:

Normal 100 Steps/Second

Hypersearch 300 Steps/Second

Service 50 Frequencies/Second

Priority Sampling 2 Seconds

Delay Time 2 Seconds

IF Frequencies 380.7 MHz, 10.85 MHz, and 450 kHz

Antenna Impedance 50 Ohms

Audio Output 350 mW maximum

Built-in Speaker 1⁷/₁₆ Inches (36 mm) 8 Ohm,
Dynamic Type

Maximum Current Drain 180 mA

Power Requirement:

4 AA Alkaline Batteries (6.0 VDC),

or 4 AA Rechargeable Ni-Cd Batteries (4.8 VDC),
or AC Adapter (Cat. No. 273-1665),
or DC Adapter (Cat. No. 270-1560)

Current Drain:

Squelched 70 mA
Full Output 180 mA

Dimensions (HWD) $6\frac{1}{4} \times 2\frac{1}{2} \times 1\frac{9}{16}$ Inches
(158 × 63 × 40 mm)

Weight (without antenna, batteries, belt clip) 8.1 oz
(229 g)

Specifications are typical; individual units might vary.
Specifications are subject to change and improvement
without notice.

NOTES

Limited One-Year Warranty

This product is warranted by RadioShack against manufacturing defects in material and workmanship under normal use for one (1) year from the date of purchase from RadioShack company-owned stores and authorized RadioShack franchisees and dealers. EXCEPT AS PROVIDED HEREIN, RadioShack MAKES NO EXPRESS WARRANTIES AND ANY IMPLIED WARRANTIES, INCLUDING THOSE OF MERCHANTABILITY AND FITNESS FOR A PARTICULAR PURPOSE, ARE LIMITED IN DURATION TO THE DURATION OF THE WRITTEN LIMITED WARRANTIES CONTAINED HEREIN. EXCEPT AS PROVIDED HEREIN, RadioShack SHALL HAVE NO LIABILITY OR RESPONSIBILITY TO CUSTOMER OR ANY OTHER PERSON OR ENTITY WITH RESPECT TO ANY LIABILITY, LOSS OR DAMAGE CAUSED DIRECTLY OR INDIRECTLY BY USE OR PERFORMANCE OF THE PRODUCT OR ARISING OUT OF ANY BREACH OF THIS WARRANTY, INCLUDING, BUT NOT LIMITED TO, ANY DAMAGES RESULTING FROM INCONVENIENCE, LOSS OF TIME, DATA, PROPERTY, REVENUE, OR PROFIT OR ANY INDIRECT, SPECIAL, INCIDENTAL, OR CONSEQUENTIAL DAMAGES, EVEN IF RadioShack HAS BEEN ADVISED OF THE POSSIBILITY OF SUCH DAMAGES.

Some states do not allow the limitations on how long an implied warranty lasts or the exclusion of incidental or consequential damages, so the above limitations or exclusions may not apply to you.

In the event of a product defect during the warranty period, take the product and the RadioShack sales receipt as proof of purchase date to any RadioShack store. RadioShack will, at its option, unless otherwise provided by law: (a) correct the defect by product repair without charge for parts and labor; (b) replace the product with one of the same or similar design; or (c) refund the purchase price. All replaced parts and products, and products on which a refund is made, become the property of RadioShack. New or reconditioned parts and products may be used in the performance of warranty service. Repaired or replaced parts and products are warranted for the remainder of the original warranty period. You will be charged for repair or replacement of the product made after the expiration of the warranty period.

This warranty does not cover: (a) damage or failure caused by or attributable to acts of God, abuse, accident, misuse, improper or abnormal usage, failure to follow instructions, improper installation or maintenance, alteration, lightning or other incidence of excess voltage or current; (b) any repairs other than those provided by a RadioShack Authorized Service Facility; (c) consumables such as fuses or batteries; (d) cosmetic damage; (e) transportation, shipping or insurance costs; or (f) costs of product removal, installation, set-up service adjustment or reinstallation.

This warranty gives you specific legal rights, and you may also have other rights which vary from state to state.

RadioShack Customer Relations, Dept. W, 100 Throckmorton St.,
Suite 600, Fort Worth, TX 76102

We Service What We Sell

3/97

RadioShack
A Division of Tandy Corporation
Fort Worth, Texas 76102